

Long-range quantum entanglement in noisy cluster states

R. Raussendorf, S. Bravyi and J. Harrington

California Institute of Technology,
Pasadena, CA, USA

Toronto, July 2004

1. Introduction

Can there exist infinite-range entanglement in thermal states at finite temperature?

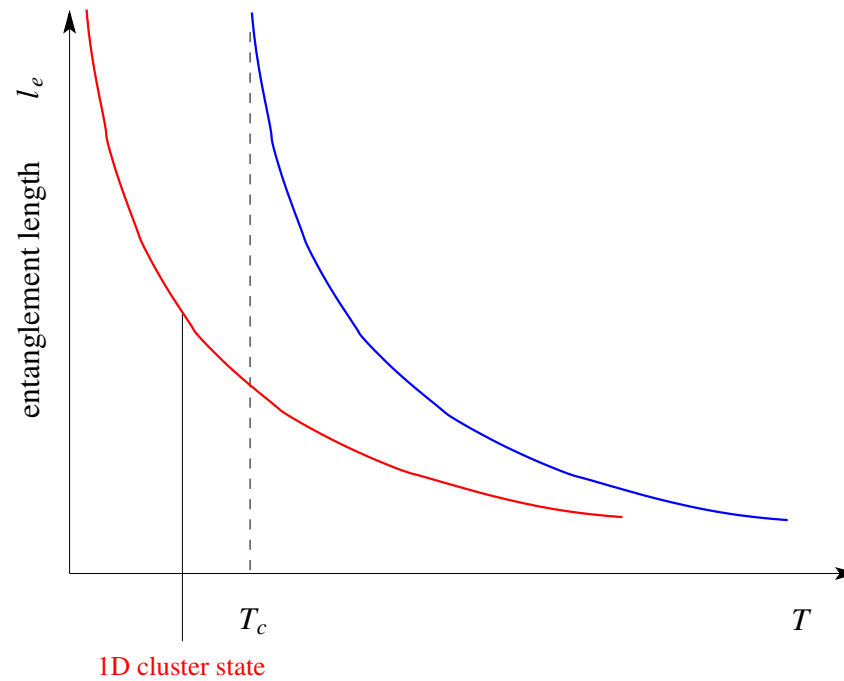

1. Introduction

Can there exist infinite-range entanglement in thermal states at finite temperature?

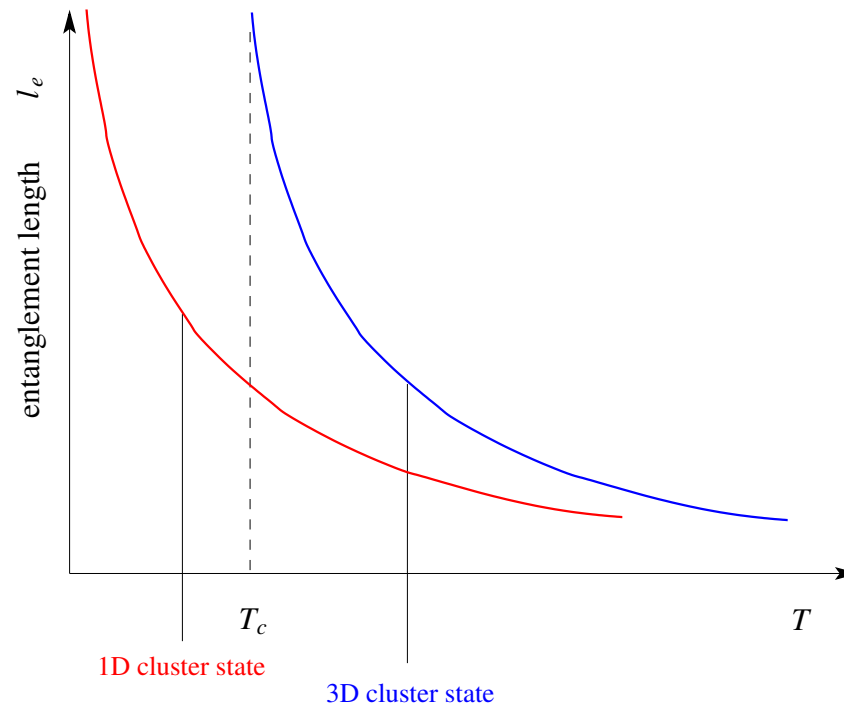

1. Introduction

Can there exist infinite-range entanglement in thermal states at finite temperature?

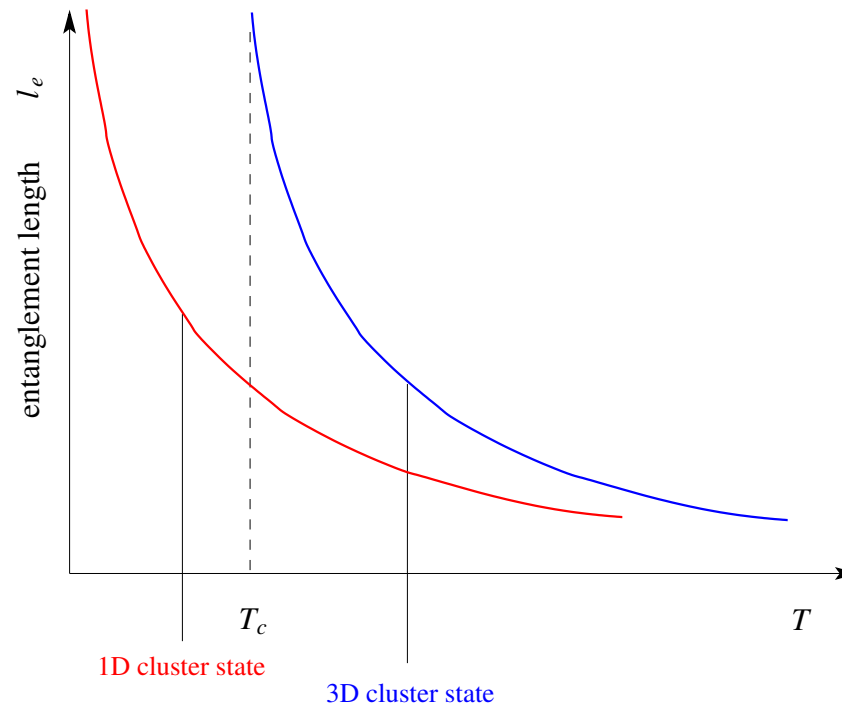

The 3D cluster state provides intrinsic error correction.

2. Model

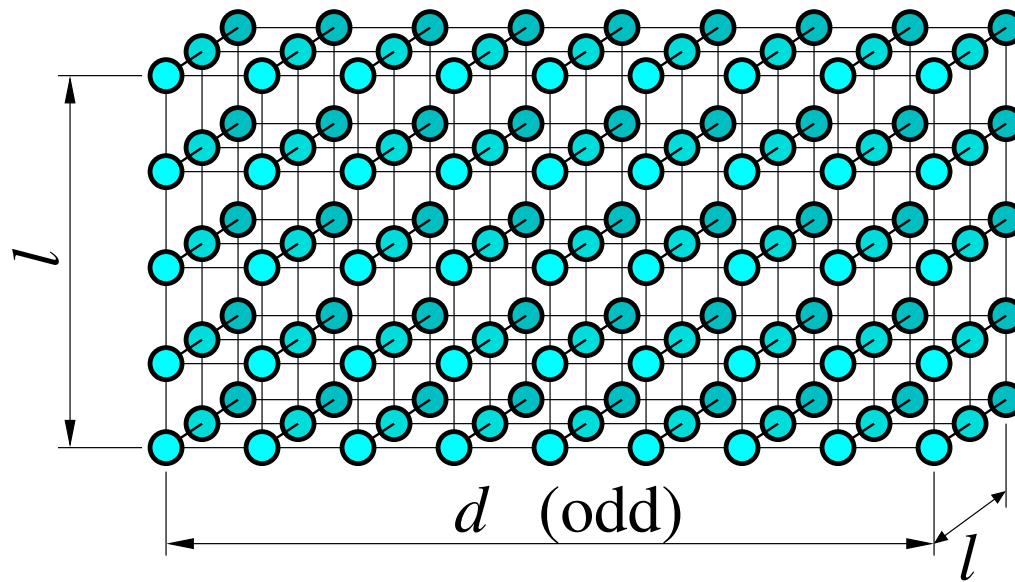

$$\rho_{\text{in}}(T) = \frac{1}{Z(T)} e^{-H/T},$$

3D thermal cluster state at temperature T .

2. Model

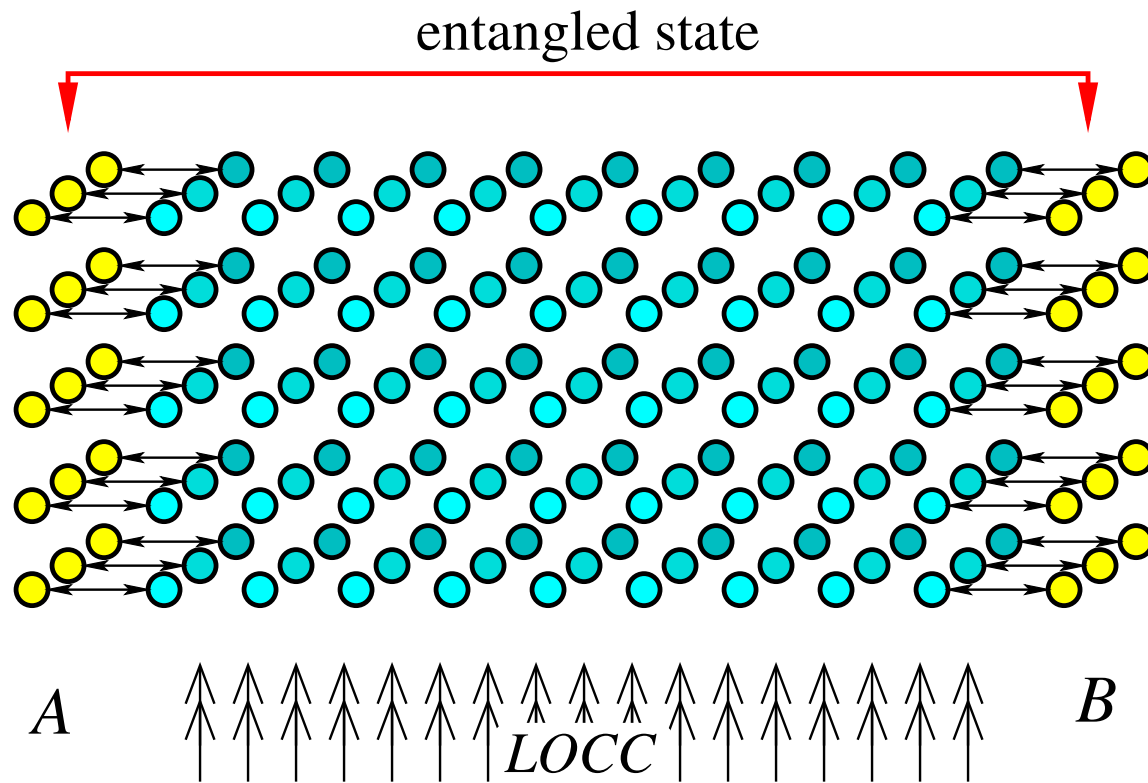

$$|\psi_{\text{out}}\rangle_{AB} \cong \overline{|0\rangle}_A \overline{|0\rangle}_B + \overline{|1\rangle}_A \overline{|1\rangle}_B$$

Output: encoded Bell state among A and B .

2. Model

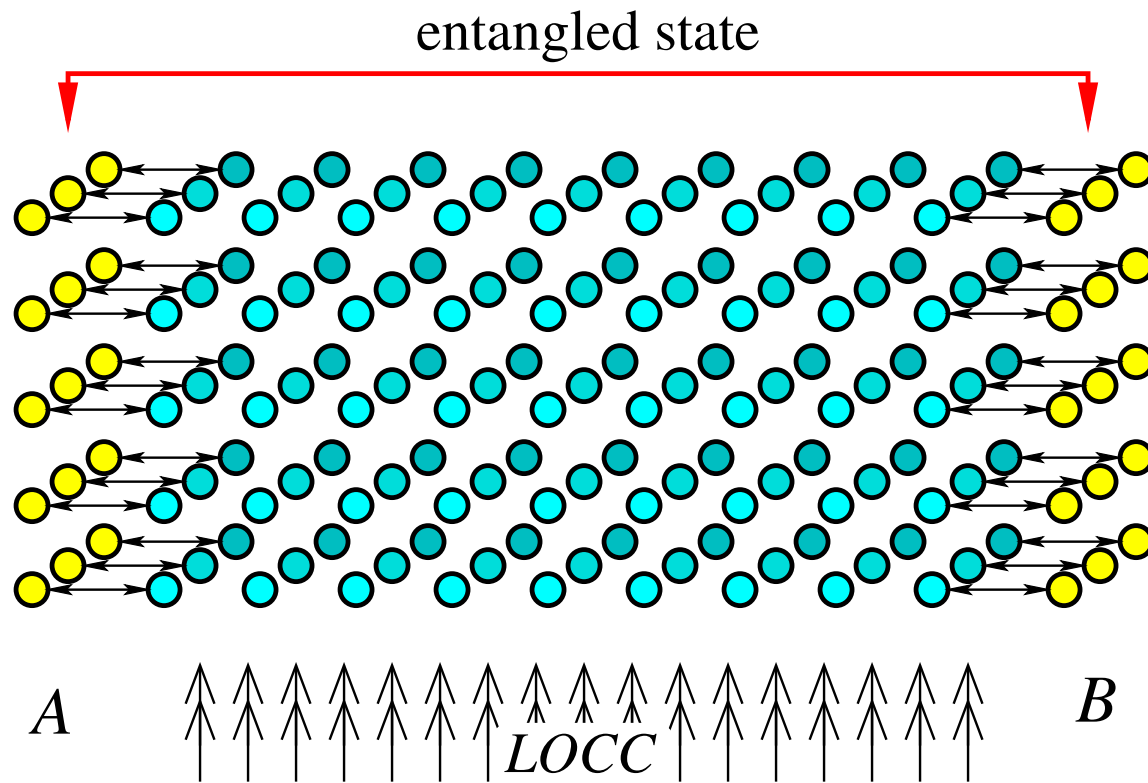

Interested in the *localizable entanglement*.

Entanglement length $L_e = d$.

2. Model: 3D thermal cluster state

We consider the Hamiltonian

$$H = -\frac{\Delta}{2} \sum_{a \in \mathcal{C}} K_a, \quad (1)$$

where $K_a = X_a \otimes_{b \in \text{nbgh}(a)} Z_b$.

The thermal cluster state $\rho_{\mathcal{C}}(T) = \frac{1}{Z} e^{-\beta H}$, $\beta \equiv 1/T$, then is

$$\rho_{\mathcal{C}}(T) = \frac{1}{2^{|\mathcal{C}|}} \prod_{a \in \mathcal{C}} \left(I + \tanh \left(\frac{\beta \Delta}{2} \right) K_a \right). \quad (2)$$

- $\rho_{\mathcal{C}}(T = 0)$ is a cluster state $|\phi\rangle_{\mathcal{C}}\langle\phi|$.

3. Result

For the 3D thermal cluster state $\rho(T)$ a transition between infinite and finite entanglement length occurs between

$$0.30 \Delta \leq T_c \leq 1.13 \Delta. \quad (3)$$

Δ : the energy gap of H .

4. Upper bound to T_c

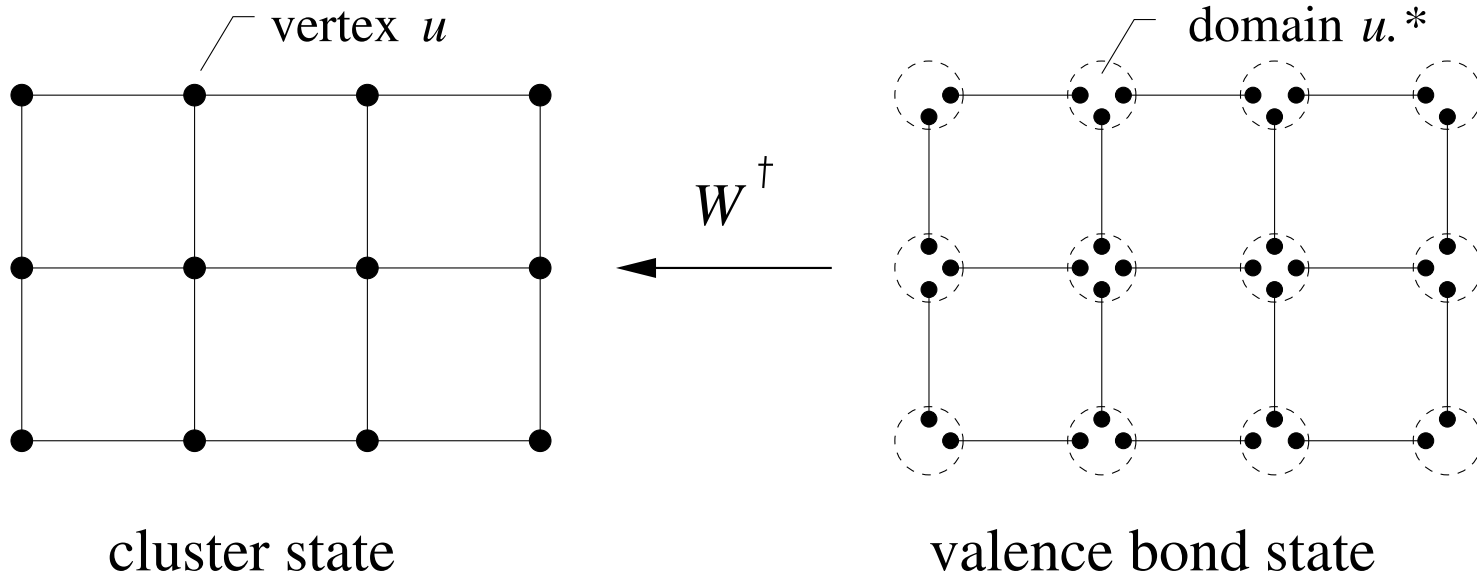

$$W^\dagger = \bigotimes_{u \in \mathcal{C}} |0\rangle_u \langle 0|^{u.^*}| + |1\rangle_u \langle 1|^{u.^*}|. \quad (4)$$

4. Upper bound to T_c

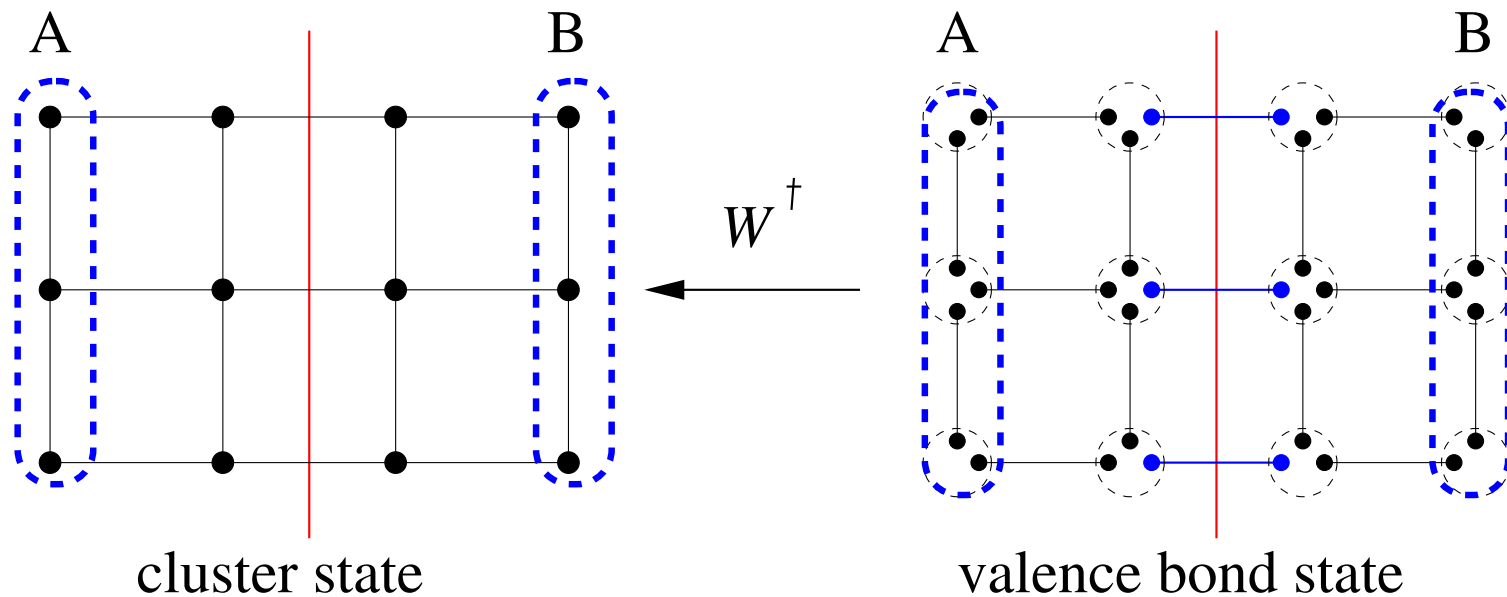

Applying the PPT separability criterion to the Bell pairs in the VBS state across the cut yields $T_c \leq 1.13 \Delta$.

5. Lower bound to T_c

3D cluster state,
measurement pattern

FT quantum memory with
the toric (or planar) code [1,2,3]

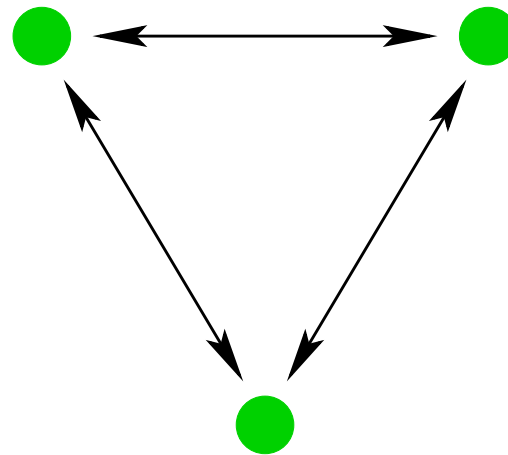

Random plaquette \mathbf{Z}_2 -gauge model in 3D [3]

[1] A. Kitaev, quant-ph/9707021 (1997).

[2] S. Bravyi, A. Kitaev, quant-ph/9810092 (1998).

[3] E. Dennis, A. Kitaev, A. Landahl and J. Preskill, quant-ph/0110143 (2001).

5.1 Error model

The thermal cluster state

$$\rho_{\mathcal{C}}(T) = \frac{1}{2^{|\mathcal{C}|}} \prod_{a \in \mathcal{C}} \left(I + \tanh \left(\frac{\beta \Delta}{2} \right) K_a \right)$$

is equivalent to local phase errors Z_a applied to the perfect cluster state, with probability

$$p = \frac{1}{1 + \exp(\beta \Delta)}. \quad (5)$$

5.2 The measurement pattern

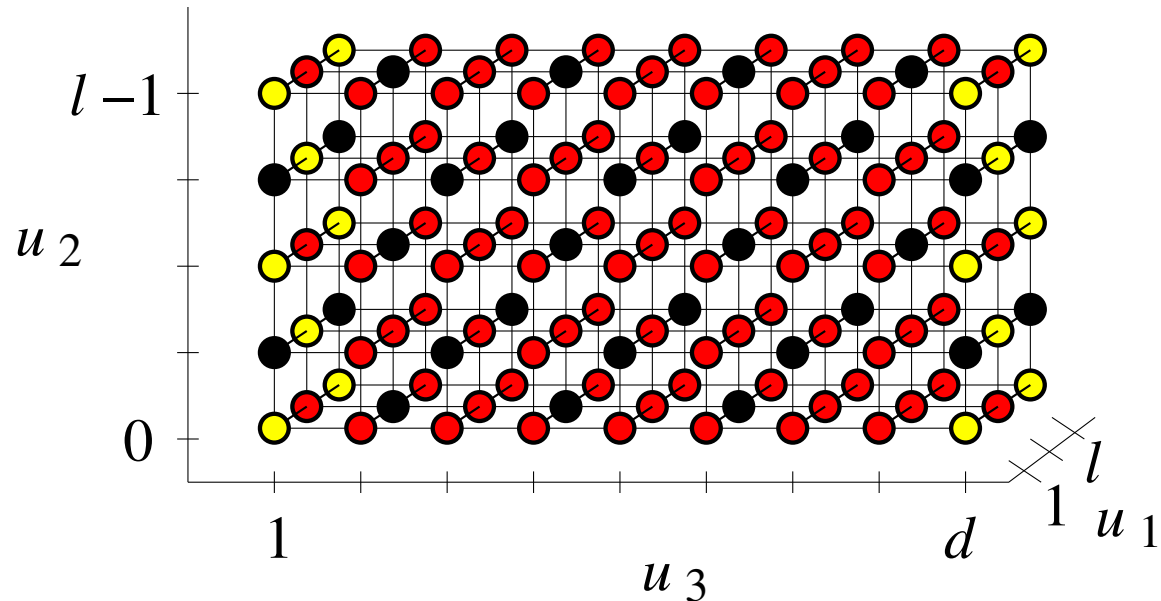

- : Not measured. $u_3 = 1, d, u_1 + u_2 = \text{odd},$
- : σ_z -measurement. $u = (e[\text{ven}], e, e), (o[\text{dd}], o, o),$ (6)
- : σ_x -measurement. otherwise.

If the qubits ●_L (left) are entangled with ●_R (right) after the local measurements, they must have been entangled before.

5.3 Mapping to the Z_2 gauge model

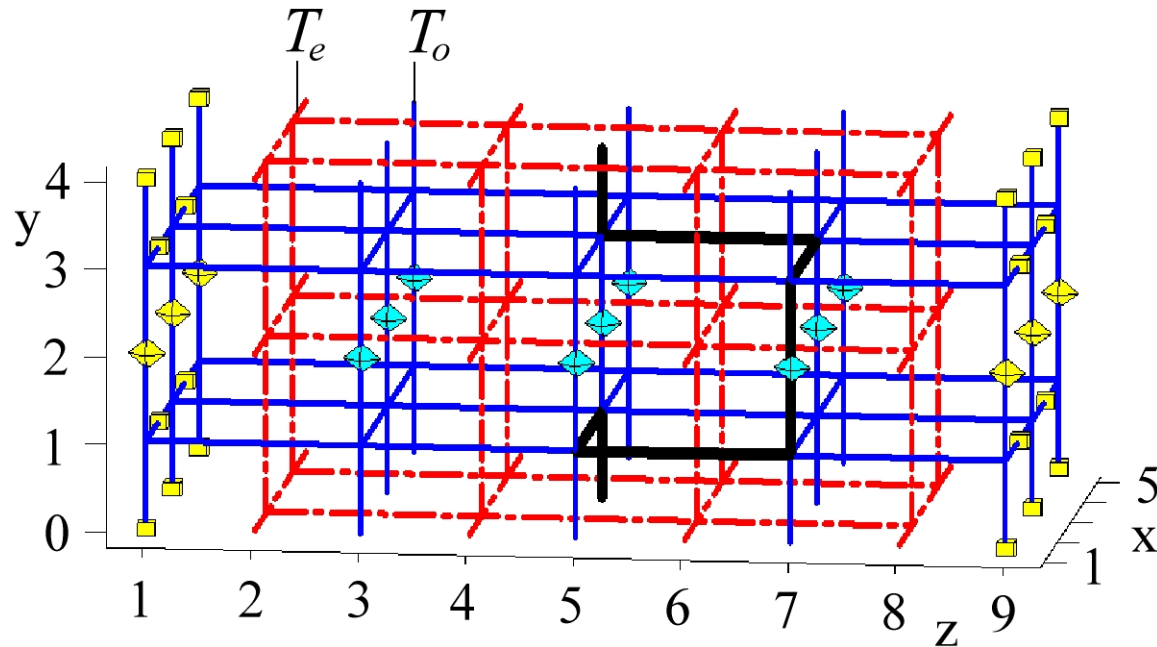

What needs to be shown:

1. Without errors: post meas. $|\psi\rangle_{LR}$ is an encoded Bell state
2. Considering errors:
 - Lattices for Z_2 gauge model: T_o and T_e (simple cubic, double spacing). T_e [T_o] mediates \overline{ZZ} - [\overline{XX}]- correlations.
 - Elementary errors on edges and syndrome bits on vertices of T_e , T_o .
 - Harmful errors: homologically nontrivial error cycles.

5.4 Lower bound to T_c

- For the described measurement pattern the measurement outcomes are *dependent* \longrightarrow error detection and correction.
- A *random plaquette Z_2 -gauge model in 3D* [1] describes the performance of error correction.
 - high-temp disordered phase: error correction fails
 - low-temp ordered phase: error correction successful

Critical error probability [2], temperature:

$$p_c = 0.033 \iff T_c = 0.3 \Delta.$$

[1] E. Dennis, A. Kitaev, A. Landahl and J. Preskill, quant-ph/0110143 (2001).

[2] T. Ohno, G. Arakawa, I. Ichinose and T. Matsui, quant-ph/0401101 (2004).

5.5 Alternative explanation for the MP

- : Not measured. $u_3 = 1, d, u_1 + u_2 = \text{odd},$
●: σ_z -measurement. $u = (e[\text{ven}], e, e), (o[\text{dd}], o, o),$
●: σ_x -measurement. otherwise.

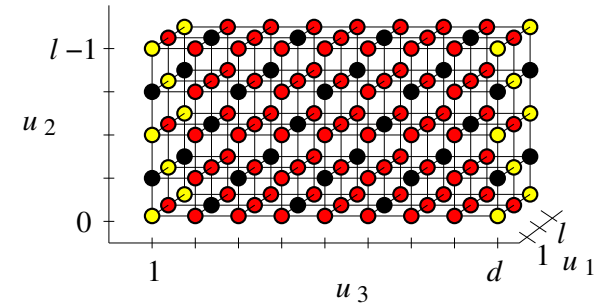

May artificially split the measurement pattern into two steps:

1. Measure the qubits with $u_1 + u_2 = \text{even}, \forall u_3.$
 \implies 1D cluster state encoded with the planar code.
2. Measure the remaining qubits, except \textcircled{Y}_L and \textcircled{Y}_R (all X).
 \cong fault-tolerant encoded \bar{X} measurements at $2 \leq u_3 \leq d-1$
 \implies encoded Bell state between \textcircled{Y}_L and \textcircled{Y}_R .

6. More general errors

- X, Y -errors can also be corrected.

Local depolarizing channel with error prob. $p_x = p_y = p_z = \frac{p'}{3}$:

- Error threshold $p'_c = 1.4\%$.
- Note: measurement pattern contains σ_z -measurements. If corresponding cluster qubits left out from the beginning, then $p''_c = 3/2 p_c = 4.9\%$.

7. Finite size effects

Numerically: For the Bell state fidelity F we find

$$F \sim \exp(-d k_1(p) \exp(-k_2(p) l)). \quad (7)$$

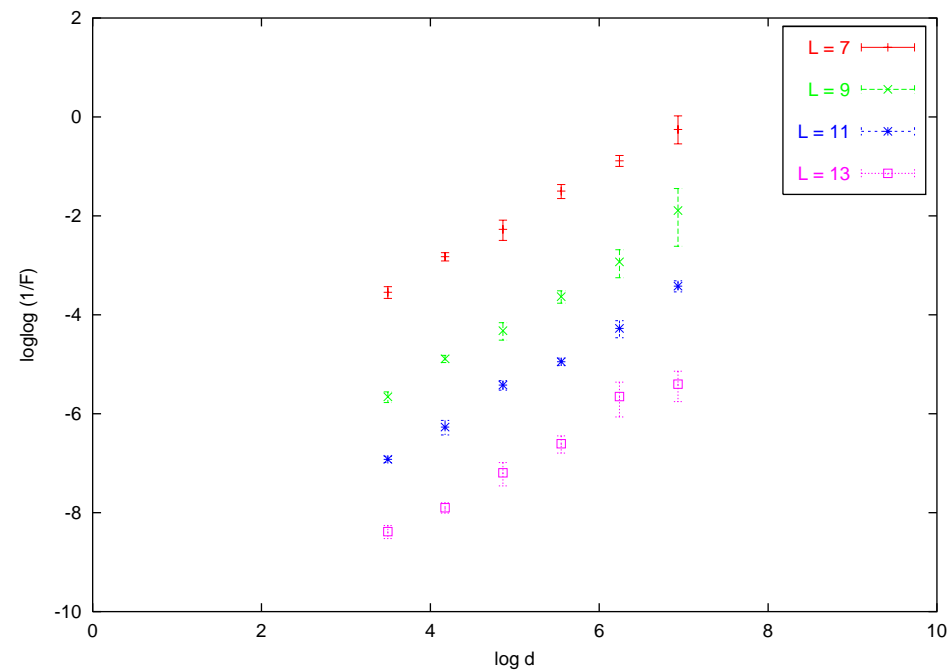

Consequence: for constant F , code block length $l \sim \log(d)$.

8. An application

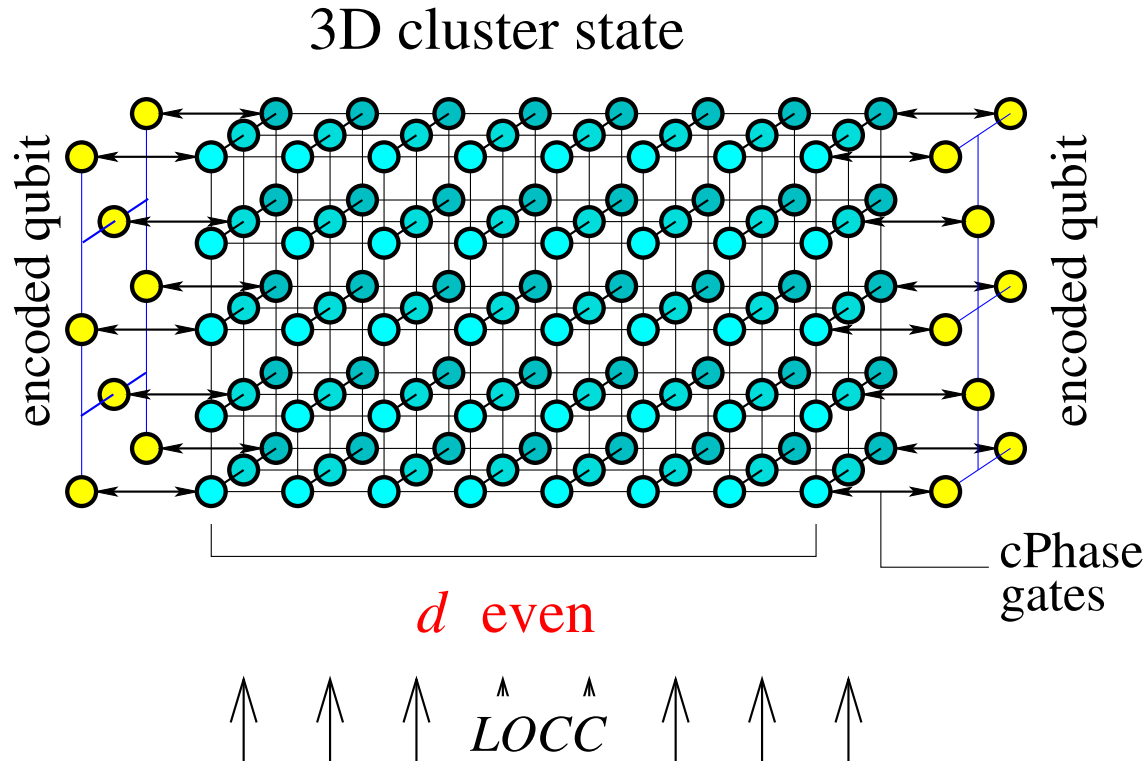

Fault-tolerant encoded long-distance cPhase gate,
mediated via short-range interaction and LOCC.

9. Summary

- The thermal cluster state exhibits a transition from infinite to finite entanglement length at a nonzero temperature T_c ,

$$0.3 \Delta \leq T_c \leq 1.13 \Delta.$$

(Δ : energy gap of the Hamiltonian)

- The reason for this behavior is an intrinsic error correction capability of 3D cluster states.
- Have established a connection

cluster states \iff surface codes.